

# SIRUBA®

銀箭牌工業用縫紉機  
INDUSTRIAL SEWING MACHINE

# F007J/F007JD

## 零件圖 PARTS LIST

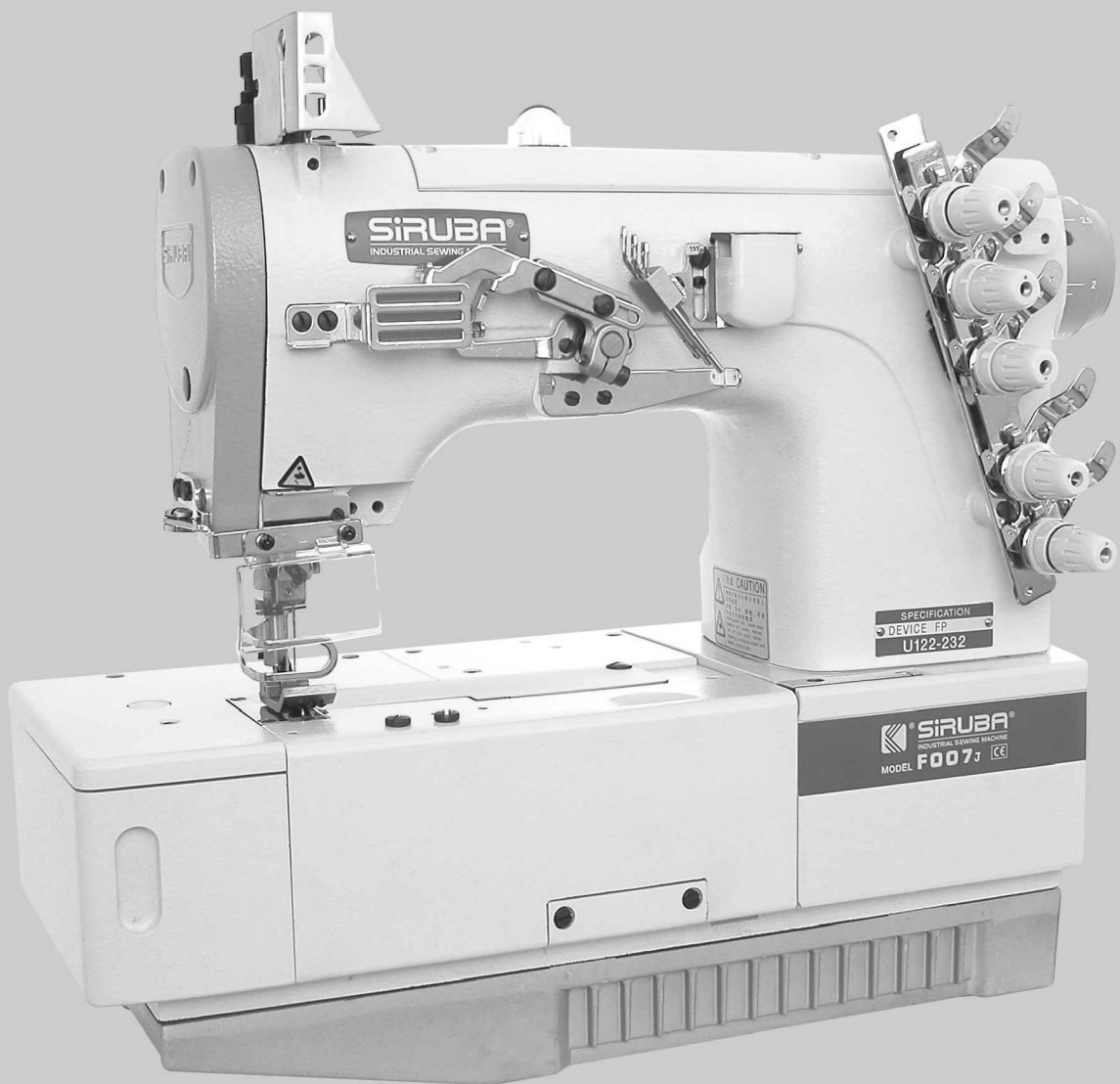

CE

 高林股份有限公司  
KAULIN MFG. CO., LTD.









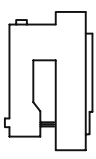

MODEL 機 型	SUB-CLASS 規 格	NEEDLE CLAMP 針 座	NEEDLE PLATE 針 板	MAIN FEED DOG 主 送 具	DIFF. FEED DOG 差 送 具	PRESSER FOOT 押 具	LOOPER 勾 針	SPREADER 上 叉	NEEDLE 針 號
F007J-W121	240 248 356 364	M5240 M5248 M5356 M5364	E1514 E1515 E1816 E1817	D1206 D1206 D1207 D1207	H1258 H1258 H1259 H1259	P2544 P2545 P2446 P2447	ME28	MH41	UY128GAS #10
F007J-W121 /UTG(UTJ)	240 248 356 364	M5240 M5248 M5356 M5364	E1514 E1515 E1816 E1817	D1206 D1206 D1207 D1207	H1258 H1258 H1259 H1259	P2544 P2545 P2446 P2447	ME28	MH41	UY128GAS #10
F007J-U121	240 248 356 364	M5240 M5248 M5356 M5364	E1514 E1515 E1816 E1817	D1206 D1206 D1207 D1207	H1258 H1258 H1259 H1259	P2544 P2545 P2446 P2447	ME28	—	UY128GAS #10
F007J-U121 /UTH(UTK)	240 248 356 364	M5240 M5248 M5356 M5364	E1514 E1515 E1816 E1817	D1206 D1206 D1207 D1207	H1258 H1258 H1259 H1259	P2544 P2545 P2446 P2447	ME28	—	UY128GAS #10
F007J-W122	240 248 356 364	M5240 M5248 M5356 M5364	E1524 E1525 E1826 E1827	D1206 D1206 D1207 D1207	H1258 H1258 H1259 H1259	P2544 P2545 P2446 P2447	ME28	MH41	UY128GAS #10
F007J-W122 /UTG(UTJ)	240 248 356 364	M5240 M5248 M5356 M5364	E1524 E1525 E1826 E1827	D1206 D1206 D1207 D1207	H1258 H1258 H1259 H1259	P2544 P2545 P2446 P2447	ME28	MH41	UY128GAS #10
F007J-U122	240 248 356 364	M5240 M5248 M5356 M5364	E1524 E1525 E1826 E1827	D1206 D1206 D1207 D1207	H1258 H1258 H1259 H1259	P2544 P2545 P2446 P2447	ME28	—	UY128GAS #10
F007J-U122 /UTH(UTK)	240 248 356 364	M5240 M5248 M5356 M5364	E1524 E1525 E1826 E1827	D1206 D1206 D1207 D1207	H1258 H1258 H1259 H1259	P2544 P2545 P2446 P2447	ME28	—	UY128GAS #10

註：P2544/2545 為固定式押具舌，亦可使用活動式押具舌 P2565代替 P2544/P2545  
P2446/2447 為固定式押具舌，亦可使用活動式押具舌 P2466代替 P2446/2447

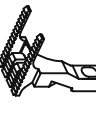
## 規格件表 CONVERSION CHART-2

MODEL 機 型	SUB-CLASS 規 格	NEEDLE CLAMP 針 座	NEEDLE PLATE 針 板	MAIN FEED DOG 主送具	DIFF. FEED DOG 差送具	PRESSER FOOT 押 具	LOOPER 勾 針	SPREADER 上 叉	NEEDLE 針 號
F007J-U122 /FP	232	M5232	E 1613	D 1206	H 1257	P 4011	ME28P	—	TV*5 #14
F007J-W 123	240 248 356 364	M5240 M5248 M5356 M5364	E 1534 E 1535 E 1836 E 1837	D 1206 D 1206 D 1207 D 1207	H 1258 H 1258 H 1259 H 1259	P 2544 P 2545 P 2446 P 2447	ME28	MH41	UY128GAS #10
F007J-W 123 /UTG(UTJ)	240 248 356 364	M5240 M5248 M5356 M5364	E 1534 E 1535 E 1836 E 1837	D 1206 D 1206 D 1207 D 1207	H 1258 H 1258 H 1259 H 1259	P 2544 P 2545 P 2446 P 2447	ME28	MH41	UY128GAS #10
F007J-W162	356 364	M5356 M5364	E 1846 E 1847	D 1207 D 1207	H 1259 H 1259	P 2446 P 2447	ME28A	MH41	TV*5 #14~16
F007J-U 162	356 364	M5356 M5364	E 1846 E 1847	D 1207 D 1207	H 1259 H 1259	P 2446 P 2447	ME28A	—	TV*5 #14~16
F007J-W162 UTG(UTJ)	356 364	M5356 M5364	E 1846 E 1847	D 1207 D 1207	H 1259 H 1259	P 2446 P 2447	ME28A	MH41	TV*5 #14~16
F007J-U 162 /UTH(UTK)	356 364	M5356 M5364	E 1846 E 1847	D 1207 D 1207	H 1259 H 1259	P 2446 P 2447	ME28A	—	TV*5 #14~16
F007J-W 222 /FQ	232 240 248 356 364	M5232 M5240 M5248 M5356 M5364	E 3023 E 3024 E 3025 E 3326 E 3327	D 1215 D 1215 D 1215 D 1216 D 1216	H 1261 H 1261 H 1261 H 1262 H 1262	P 1813 P 1814 P 1815 P 2116 P 2117	ME28	MH41	UY128GAS #10
F007J-W 222 /UTG(UTJ)/FQ	240 248 356 364	M5240 M5248 M5356 M5364	E 3024 E 3025 E 3326 E 3327	D 1215 D 1215 D 1216 D 1216	H 1261 H 1261 H 1262 H 1262	P 1814 P 1815 P 2116 P 2117	ME28	MH41	UY128GAS #10
F007J-U 222 /UTH(UTK)/FQ	240 248 356 364	M5240 M5248 M5356 M5364	E 3024 E 3025 E 3326 E 3327	D 1215 D 1215 D 1216 D 1216	H 1261 H 1261 H 1262 H 1262	P 1814 P 1815 P 2116 P 2117	ME28	MH41	UY128GAS #10

註：P 2544/2545 為固定式押具舌，亦可使用活動式押具舌 P 2565代替P2544/P2545  
P 2446/2447 為固定式押具舌，亦可使用活動式押具舌 P 2466代替P2446/2447

									
MODEL	SUB-CLASS	NEEDLE CLAMP	NEEDLE PLATE	MAIN FEED DOG	DIFF. FEED DOG	PRESSER FOOT	LOOPER	SPREADER	NEEDLE
機型	規格	針座	針板	主送具	差送具	押具	勾針	上叉	針號
F007J-W222 /FQ/FEC(FAC)	240 248 356 364	M5240 M5248 M5356 M5364	E 3024 E 3025 E 3326 E 3327	D 1215 D 1215 D 1216 D 1216	H 1261 H 1261 H 1262 H 1262	P 1814 P 1815 P 2116 P 2117	ME28	MH41	UY128GAS #10
F007J-U222 /FQ	240 248 356 364	M5240 M5248 M5356 M5364	E 3024 E 3025 E 3326 E 3327	D 1215 D 1215 D 1216 D 1216	H 1261 H 1261 H 1262 H 1262	P 2314 P 2315 P 2616 P 2617	ME28	—	UY128GAS #10
F007J-W222A FQ/FEC(FAC)	240 248 356 364	M5240 M5248 M5356 M5364	E 3124 E 3125 E 3426 E 3427	D 1315 D 1315 D 1316 D 1316	H 1261 H 1261 H 1262 H 1262	P 1914 P 1915 P 2216 P 2217	ME28	MH41	UY128GAS #10
F007J-W222 /FFD(FFP)	240 248 356 364	M5240 M5248 M5356 M5364	E 3024 E 3025 E 3326 E 3327	D 1215 D 1215 D 1216 D 1216	H 1261 H 1261 H 1262 H 1262	P 1814 P 1815 P 2116 P 2117	ME28	MH41	UY128GAS #10
F007J-U222 /FFD(FFP)	240 248 356 364	M5240 M5248 M5356 M5364	E 3024 E 3025 E 3326 E 3327	D 1215 D 1215 D 1216 D 1216	H 1261 H 1261 H 1262 H 1262	P 2314 P 2315 P 2616 P 2617	ME28	—	UY128GAS #10
F007J-W222 /FSM	240-4 248-4 364-4	M5240P M5248P M5364P	E 3724 E 3725 E 3727	D 1516	H 1262 H 1262 H 1262	P 2714 P 2715 P 2717	ME28	MH41	UY128GAS #10
F007J-W322 /FDC	356 364	M5356 M5364	E 4826 E 4827	D 1207 D 1207	H 1359 H 1359	P 2446 P 2447	ME28	MH41	UY128GAS #10
F007J-W322 /UTG(UTJ)/FDC	356 364	M5356 M5364	E 4826 E 4827	D 1207 D 1207	H 1359 H 1359	P 2446 P 2447	ME28	MH41	UY128GAS #10
F007J-U322 /FDC	356 364	M5356 M5364	E 4826 E 4827	D 1207 D 1207	H 1359 H 1359	P 2446 P 2447	ME28	—	UY128GAS #10

W222A-FAC(FEC) 短切刀

W222-FAC(FEC) 長切刀

註：P2544/2545 為固定式押具舌,亦可使用活動式押具舌 P2565 代替 P2544/P2545

P2446/2447 為固定式押具舌,亦可使用活動式押具舌 P2466 代替 P2446/2447

## 規格件表 CONVERSION CHART-3

# 規格件表 CONVERSION CHART-4

MODEL 機型	SUB-CLASS 規格	NEEDLE CLAMP 針座	NEEDLE PLATE 針板	MAIN FEED DOG 主送具	DIFF. FEED DOG 差送具	PRESSER FOOT 押具	LOOPER 勾針	SPREADER 上叉	NEEDLE 針號
F007J-U322 /UTH(UTK)/FDC	356 364	M5356 M5364	E 4826 E 4827	D1207 D1207	H1359 H1359	P2446 P2447	ME28	—	UY128GAS #10
F007J-W322 /FDE	356 364	M5356 M5364	E 4836M E 4837M	D1207 D1207	H1459 H1459	P2446 P2447	ME28	MH41	UY128GAS #10
F007J-W322 /UTG(UTJ)/FDE	356 364	M5356 M5364	E 4836M E 4837M	D1207 D1207	H1459 H1459	P2446 P2447	ME28	MH41	UY128GAS #10
F007J-U322 /FDE	356 364	M5356 M5364	E 4836M E 4837M	D1207 D1207	H1459 H1459	P2446 P2447	ME28	—	UY128GAS #10
F007J-U322 /UTH(UTK)/FDE	356 364	M5356 M5364	E 4836M E 4837M	D1207 D1207	H1459 H1459	P2446 P2447	ME28	—	UY128GAS #10
F007J-W522 /FE(FFC)/FR	232 240 248 356 364	M5232 M5240 M5248 M5356 M5364	E 6023 E 6024 E 6025 E 6326 E 6327	D 2221 D 2221 D 2221 D 2222 D 2222	H 2267 H 2267 H 2267 H 2268 H 2268	P 2813 P 2814 P 2815 P 3116 P 3117	ME28	MH41	UY128GAS #10
F007J-U522 /FE(FFC)/FR	240 248 356 364	M5240 M5248 M5356 M5364	E 6024 E 6025 E 6326 E 6327	D 2221 D 2221 D 2222 D 2222	H 2267 H 2267 H 2268 H 2268	P 2814 P 2815 P 3116 P 3117	ME28	—	UY128GAS #10

註： F007J-W/U322A-356 /FDC 時，該針板與送具改用 F007H-W/U122-364 之針板與送具  
 註： P2544/2545 為固定式押具舌，亦可使用活動式押具舌 P2565代替 P2544/P2545  
 P2446/2447 為固定式押具舌，亦可使用活動式押具舌 P2466代替 P2446/2447







MODEL 機型	SUB-CLASS 規格	NEEDLE CLAMP 針座	NEEDLE PLATE 針板	MAIN FEED DOG 主送具	DIFF. FEED DOG 差送具	PRESSER FOOT 押具	LOOPER 勾針	SPREADER 上叉	NEEDLE 針號
F007J-W512 /FE(FFC)	240 248 356 364	M5240 M5248 M5356 M5364	E 1524 E 1525 E 1826 E 1827	D 1206 D 1206 D 1207 D 1207	H 1258 H 1258 H 1259 H 1259	P 2914 P 2915 P 3216 P 3217	ME28	MH41	UY128GAS #10
F007J-U512 /FE(FFC)	240 248 356 364	M5240 M5248 M5356 M5364	E 1524 E 1525 E 1826 E 1827	D 1206 D 1206 D 1207 D 1207	H 1258 H 1258 H 1259 H 1259	P 3414 P 3415 P 3716 P 3717	ME28	—	UY128GAS #10

註：F007J-W/U322A-<sup>356</sup> /FDC 時，該針板與送具改用 F007H-W/U122-<sup>364</sup> 之針板與送具

註：P2544/2545 為固定式押具舌，亦可使用活動式押具舌 P2565 代替 P2544/P2545  
P2446/2447 為固定式押具舌，亦可使用活動式押具舌 P2466 代替 P2446/2447

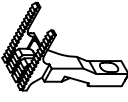
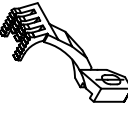
# 規格件表 CONVERSION CHART-6

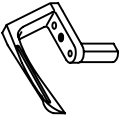
MODEL 機 型	SUB-CLASS 規 格	NEEDLE CLAMP 針 座	NEEDLE PLATE 針 板	MAIN FEED DOG 主 送 具	DIFF. FEED DOG 差 送 具	PRESSER FOOT 押 具	LOOPER 勾 針	SPREADER 上 叉	NEEDLE 針 號
F007J-U613 /FBP	256	M5356	E 1836L	D 1207	H 1259	P 4000	ME28	—	TV*5 #14~18
	264	M5364	E 1837L	D 1207	H 1259	P 4001	ME28	—	
F007J-U712	264	M5264	E 5827	D 5207	H 5259	P 4117	ME28	—	TV*3 #11~16
F007J-U712 /FSP	264	M5264	E 5827	D 5207	H 5259	P5117(成品寬1.0mm用)	FS03/04	—	TV*3 #11~16
F007J-U712A /FSP	264	M5264	E 5827	D 5207	H 5259	P5118(成品寬1.2mm用)	FS03/04	—	TV*3 #11~16
F007J-U712 /FSR	264	M5264	E 5927	D 5307	H 5359	P 4217	FS03/04	—	TV*7 #12~14
F007J-W722 /FY	388	M4388	E 6828	D 6207	H 6259	P 6117	FS03/04/FY02	FY09	TV*7 #12
F007J-W922 /FW(FWP)	456 460 464	M5456 M5460 M5464	E1828P E1838P E1848P	D1207P	H1259	P2428P P2438P P2448P	FW28	MH41	SM1014B #10 (MY1014B #70 ,SY7256)

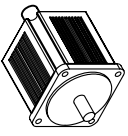
MODEL	SUB-CLASS	NEEDLE CLAMP	NEEDLE PLATE	MAIN FEED DOG	DIFF. FEED DOG	PRESSER FOOT	LOOPER	SPREADER	NEEDLE	Motor
										
機型	規格	針座	針板	主送具	差送具	押具	勾針	上叉	針號	馬達
F007JD-W121	240 248 356 364	M5240 M5248 M5356 M5364	E1514 E1515 E1816 E1817	D1206 D1206 D1207 D1207	H1258 H1258 H1259 H1259	P2544 P2545 P2446 P2447	ME28	MH41	UY128GAS #10	T6401UHM
F007JD-W121 /UTH(UTJ)	240 248 356 364	M5240 M5248 M5356 M5364	E1514 E1515 E1816 E1817	D1206 D1206 D1207 D1207	H1258 H1258 H1259 H1259	P2544 P2545 P2446 P2447	ME28	MH41	UY128GAS #10	
F007JD-U121	240 248 356 364	M5240 M5248 M5356 M5364	E1514 E1515 E1816 E1817	D1206 D1206 D1207 D1207	H1258 H1258 H1259 H1259	P2544 P2545 P2446 P2447	ME28	—	UY128GAS #10	
F007JD-U121 /UTH(UTK)	240 248 356 364	M5240 M5248 M5356 M5364	E1514 E1515 E1816 E1817	D1206 D1206 D1207 D1207	H1258 H1258 H1259 H1259	P2544 P2545 P2446 P2447	ME28	—	UY128GAS #10	
F007JD-W122	240 248 356 364	M5240 M5248 M5356 M5364	E1524 E1525 E1826 E1827	D1206 D1206 D1207 D1207	H1258 H1258 H1259 H1259	P2544 P2545 P2446 P2447	ME28	MH41	UY128GAS #10	
F007JD-W122 /UTG(UTJ)	240 248 356 364	M5240 M5248 M5356 M5364	E1524 E1525 E1826 E1827	D1206 D1206 D1207 D1207	H1258 H1258 H1259 H1259	P2544 P2545 P2446 P2447	ME28	MH41	UY128GAS #10	
F007JD-U122	240 248 356 364	M5240 M5248 M5356 M5364	E1524 E1525 E1826 E1827	D1206 D1206 D1207 D1207	H1258 H1258 H1259 H1259	P2544 P2545 P2446 P2447	ME28	—	UY128GAS #10	
F007JD-U122 /UTH(UTK)	240 248 356 364	M5240 M5248 M5356 M5364	E1524 E1525 E1826 E1827	D1206 D1206 D1207 D1207	H1258 H1258 H1259 H1259	P2544 P2545 P2446 P2447	ME28	—	UY128GAS #10	

註：P2544/2545 為固定式押具舌，亦可使用活動式押具舌 P2565代替 P2544/P2545  
P2446/2447 為固定式押具舌，亦可使用活動式押具舌 P2466代替 P2446/2447



# 規格件表 CONVERSION CHART-8

MODEL	SUB-CLASS	NEEDLE CLAMP	NEEDLE PLATE	MAIN FEED DOG	DIFF. FEED DOG	PRESSER FOOT	LOOPER	SPREADER	NEEDLE	Motor
機型	規格	針座	針板	主送具	差送具	押具	勾針	上叉	針號	馬達
F007JD-U122 /FP	232	M5232	E 1613	D 1206	H 1257	P 4011	ME28P	—	TV*5 #14	□ T6401UHM
F007JD-W123	240	M5240	E 1534	D 1206	H 1258	P 2544	ME28	MH41	UY128GAS #10	
	248	M5248	E 1535	D 1206	H 1258	P 2545				
	356	M5356	E 1836	D 1207	H 1259	P 2446				
	364	M5364	E 1837	D 1207	H 1259	P 2447				
F007JD-W123 /UTG(UTJ)	240	M5240	E 1534	D 1206	H 1258	P 2544	ME28	MH41	UY128GAS #10	
	248	M5248	E 1535	D 1206	H 1258	P 2545				
	356	M5356	E 1836	D 1207	H 1259	P 2446				
	364	M5364	E 1837	D 1207	H 1259	P 2447				
F007JD-W162	356	M5356	E 1846	D 1207	H 1259	P 2446	ME28A	MH41	TV*5 #14~16	
	364	M5364	E 1847	D 1207	H 1259	P 2447				
F007JD-U162	356	M5356	E 1846	D 1207	H 1259	P 2446	ME28A	—	TV*5 #14~16	
	364	M5364	E 1847	D 1207	H 1259	P 2447				
F007JD-W162 /UTG(UTJ)	356	M5356	E 1846	D 1207	H 1259	P 2446	ME28A	MH41	TV*5 #14~16	
	364	M5364	E 1847	D 1207	H 1259	P 2447				
F007JD-U162 /UTH(UTK)	356	M5356	E 1846	D 1207	H 1259	P 2446	ME28A	—	TV*5 #14~16	
	364	M5364	E 1847	D 1207	H 1259	P 2447				
F007JD-W222 /FQ	240	M5240	E 3024	D 1215	H 1261	P 1814	ME28	MH41	UY128GAS #10	
	248	M5248	E 3025	D 1215	H 1261	P 1815				
	356	M5356	E 3326	D 1216	H 1262	P 2116				
	364	M5364	E 3327	D 1216	H 1262	P 2117				
F007JD-W222 /UTG(UTJ)/FQ	240	M5240	E 3024	D 1215	H 1261	P 1814	ME28	MH41	UY128GAS #10	
	248	M5248	E 3025	D 1215	H 1261	P 1815				
	356	M5356	E 3326	D 1216	H 1262	P 2116				
	364	M5364	E 3327	D 1216	H 1262	P 2117				
F007JD-U222 /UTH(UTK)/FQ	240	M5240	E 3024	D 1215	H 1261	P 1814	ME28	MH41	UY128GAS #10	
	248	M5248	E 3025	D 1215	H 1261	P 1815				
	356	M5356	E 3326	D 1216	H 1262	P 2116				
	364	M5364	E 3327	D 1216	H 1262	P 2117				

註：P2544/2545 為固定式押具舌,亦可使用活動式押具舌 P2565代替P2544/P2545  
P2446/2447 為固定式押具舌,亦可使用活動式押具舌 P2466代替P2446/2447

MODEL	SUB-CLASS	NEEDLE CLAMP	NEEDLE PLATE	MAIN FEED DOG	DIFF. FEED DOG	PRESSER FOOT	LOOPER	SPREADER	NEEDLE	Motor
機型	規格	針座	針板	主送具	差送具	押具	勾針	上叉	針號	馬達
F007JD-W222 /Fq/FEC(FAC)	240 248 356 364	M5240 M5248 M5356 M5364	E 3024 E 3025 E 3326 E 3327	D1215 D1215 D1216 D1216	H1261 H1261 H1262 H1262	P1814 P1815 P2116 P2117	ME28	MH41	UY128GAS #10	T6401UHM
F007JD-U222 /FQ	240 248 356 364	M5240 M5248 M5356 M5364	E 3024 E 3025 E 3326 E 3327	D1215 D1215 D1216 D1216	H1261 H1261 H1262 H1262	P2314 P2315 P2616 P2617	ME28	—	UY128GAS #10	
F007JD-W222A Fq/FEC(FAC)	240 248 356 364	M5240 M5248 M5356 M5364	E 3124 E 3125 E 3426 E 3427	D1315 D1315 D1316 D1316	H1261 H1261 H1262 H1262	P1914 P1915 P2216 P2217	ME28	MH41	UY128GAS #10	
F007JD-W222 /FFP	240 248 356 364	M5240 M5248 M5356 M5364	E 3024 E 3025 E 3326 E 3327	D1215 D1215 D1216 D1216	H1261 H1261 H1262 H1262	P1814 P1815 P2116 P2117	ME28	MH41	UY128GAS #10	
F007JD-U222 /FFP	240 248 356 364	M5240 M5248 M5356 M5364	E 3024 E 3025 E 3326 E 3327	D1215 D1215 D1216 D1216	H1261 H1261 H1262 H1262	P2314 P2315 P2616 P2617	ME28	—	UY128GAS #10	
F007JD-W322 /FDC	356 364	M5356 M5364	E 4826 E 4827	D1207 D1207	H1359 H1359	P2446 P2447	ME28	MH41	UY128GAS #10	
F007JD-W322 /UTG(Utj)/FDC	356 364	M5356 M5364	E 4826 E 4827	D1207 D1207	H1359 H1359	P2446 P2447	ME28	MH41	UY128GAS #10	
F007JD-U322 /FDC	356 364	M5356 M5364	E 4826 E 4827	D1207 D1207	H1359 H1359	P2446 P2447	ME28	—	UY128GAS #10	
F007JD-U322 /UTH(UTK)/FDC	356 364	M5356 M5364	E 4826 E 4827	D1207 D1207	H1359 H1359	P2446 P2447	ME28	—	UY128GAS #10	

W222A-FAC(FEC) 短切刀

W222-FAC(FEC) 長切刀

註：P2544/2545 為固定式押具舌，亦可使用活動式押具舌 P2565 代替 P2544/P2545  
P2446/2447 為固定式押具舌，亦可使用活動式押具舌 P2466 代替 P2446/2447





## 規格件表 CONVERSION CHART-9

# 規格件表 CONVERSION CHART-10

MODEL	SUB-CLASS	NEEDLE CLAMP	NEEDLE PLATE	MAIN FEED DOG	DIFF. FEED DOG	PRESSER FOOT	LOOPER	SPREADER	NEEDLE	Motor
機 型	規 格	針 座	針 板	主 送 具	差 送 具	押 具	勾 針	上 叉	針 號	馬 達
F007JD-W322 /FDE	356 364	M5356 M5364	E 4836M E 4837M	D1207 D1207	H1459 H1459	P2446 P2447	ME28	MH41	UY128GAS #10	T6401UHM
F007JD-W322 /UTG(UTJ)/FDE	356 364	M5356 M5364	E 4836M E 4837M	D1207 D1207	H1459 H1459	P2446 P2447	ME28	MH41	UY128GAS #10	
F007JD-U322 /FDE	356 364	M5356 M5364	E 4836M E 4837M	D1207 D1207	H1459 H1459	P2446 P2447	ME28	—	UY128GAS #10	
F007JD-U322 /UTH(UTK)/FDE	356 364	M5356 M5364	E 4836M E 4837M	D1207 D1207	H1459 H1459	P2446 P2447	ME28	—	UY128GAS #10	
F007JD-W522 /FE/FR	240 248 356 364	M5240 M5248 M5356 M5364	E 6024 E 6025 E 6326 E 6327	D 2221 D 2221 D 2222 D 2222	H 2267 H 2267 H 2268 H 2268	P2814 P2815 P3116 P3117	ME28	MH41	UY128GAS #10	
F007JD-U522 /FE/FR	240 248 356 364	M5240 M5248 M5356 M5364	E 6024 E 6025 E 6326 E 6327	D 2221 D 2221 D 2222 D 2222	H 2267 H 2267 H 2268 H 2268	P2814 P2815 P3116 P3117	ME28	—	UY128GAS #10	
F007JD-W512 /FE	240 248 356 364	M5240 M5248 M5356 M5364	E 1524 E 1525 E 1826 E 1827	D 1206 D 1206 D 1207 D 1207	H 1258 H 1258 H 1259 H 1259	P 2914 P 2915 P 3216 P 3217	ME28	MH41	UY128GAS #10	
F007JD-U512 /FE	240 248 356 364	M5240 M5248 M5356 M5364	E 1524 E 1525 E 1826 E 1827	D 1206 D 1206 D 1207 D 1207	H 1258 H 1258 H 1259 H 1259	P 3414 P 3415 P 3716 P 3717	ME28	—	UY128GAS #10	

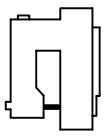
註： F007JD-W/U322A-356 /FDC 時，該針板與送具改用 F007H-W/U122-364 之針板與送具

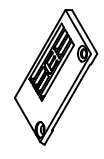
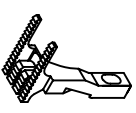
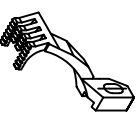
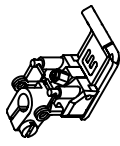
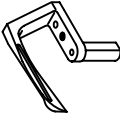
註： P2544/2545 為固定式押具舌，亦可使用活動式押具舌 P2565 代替 P2544/P2545  
P2446/2447 為固定式押具舌，亦可使用活動式押具舌 P2466 代替 P2446/2447

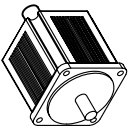
										
MODEL	SUB-CLASS	NEEDLE CLAMP	NEEDLE PLATE	MAIN FEED DOG	DIFF. FEED DOG	PRESSER FOOT	LOOPER	SPREADER	NEEDLE	Motor
機型	規格	針座	針板	主送具	差送具	押具	勾針	上叉	針號	馬達
F007JD-U613 /FBP	256	M5356	E 1836L	D 1207	H 1259	P 4000	ME28	—	TV*5 #14~18	馬達 T6401UHM
F007JD-U712	264	M5364	E 1837L	D 1207	H 1259	P 4001	ME28	—	TV*3 #11~16	
F007JD-U712 /FSP	264	M5264	E 5827	D 5207	H 5259	P 4117	ME28	—	TV*3 #11~16	
F007JD-U712A /FSP	264	M5264	E 5827	D 5207	H 5259	P5117(成齒寬1.0mm用)	FS03/04	—	TV*3 #11~16	
F007JD-U712 /FSR	264	M5264	E 5827	D 5207	H 5259	P5118(成齒寬1.2mm用)	FS03/04	—	TV*3 #11~16	
F007JD-W722 /FY	388	M4388	E 6828	D 6207	H 5359	P 4217	FS03/04	—	TV*7 #12~14	
F007JD-W922 /FW(FWP)	456 460 464	M5456 M5460 M5464	E1828P E1838P E1848P	D1207P	H1259	P2428P P2438P P2448P	FW28	FY09	TV*7 #12 SM1014B #10 (MY1014B #70 ,SY7256)	

F007J: 為一般馬達,外置式機種 ; F007JD: 為加裝直驅伺服馬達機種

# 規格件表 CONVERSION CHART-12

MODEL	SUB-CLASS	NEEDLE CLAMP	NEEDLE PLATE	MAIN FEED DOG	DIFF. FEED DOG	PRESSER FOOT	LOOPER	SPREADER	NEEDLE	Motor
機型	規格	針座	針板	主送具	差送具	押具	勾針	上叉	針號	馬達
F007JD-W121 /K	240 248 356 364	M5240 M5248 M5356 M5364	E 1514 E 1515 E 1816 E 1817	D1206 D1206 D1207 D1207	H1258 H1258 H1259 H1259	P2544 P2545 P2446 P2447	ME28	MH41	UY128GAS #10	PT6400UPM
F007JD-W121 /UTG(UTJ)/K	240 248 356 364	M5240 M5248 M5356 M5364	E 1514 E 1515 E 1816 E 1817	D1206 D1206 D1207 D1207	H1258 H1258 H1259 H1259	P2544 P2545 P2446 P2447	ME28	MH41	UY128GAS #10	
F007JD-U121 /K	240 248 356 364	M5240 M5248 M5356 M5364	E 1514 E 1515 E 1816 E 1817	D1206 D1206 D1207 D1207	H1258 H1258 H1259 H1259	P2544 P2545 P2446 P2447	ME28	—	UY128GAS #10	
F007JD-U121 /UTH(UTK)/K	240 248 356 364	M5240 M5248 M5356 M5364	E 1514 E 1515 E 1816 E 1817	D1206 D1206 D1207 D1207	H1258 H1258 H1259 H1259	P2544 P2545 P2446 P2447	ME28	—	UY128GAS #10	
F007JD-W122 /K	240 248 356 364	M5240 M5248 M5356 M5364	E 1524 E 1525 E 1826 E 1827	D1206 D1206 D1207 D1207	H1258 H1258 H1259 H1259	P2544 P2545 P2446 P2447	ME28	MH41	UY128GAS #10	
F007JD-W122 /UTG(UTJ)/K	240 248 356 364	M5240 M5248 M5356 M5364	E 1524 E 1525 E 1826 E 1827	D1206 D1206 D1207 D1207	H1258 H1258 H1259 H1259	P2544 P2545 P2446 P2447	ME28	MH41	UY128GAS #10	
F007JD-U122 /K	240 248 356 364	M5240 M5248 M5356 M5364	E 1524 E 1525 E 1826 E 1827	D1206 D1206 D1207 D1207	H1258 H1258 H1259 H1259	P2544 P2545 P2446 P2447	ME28	—	UY128GAS #10	
F007JD-U122 /UTH(UTK)/K	240 248 356 364	M5240 M5248 M5356 M5364	E 1524 E 1525 E 1826 E 1827	D1206 D1206 D1207 D1207	H1258 H1258 H1259 H1259	P2544 P2545 P2446 P2447	ME28	—	UY128GAS #10	

註：P2544/2545 為固定式押具舌，亦可使用活動式押具舌 P2565代替 P2544/P2545  
 P2446/2447 為固定式押具舌，亦可使用活動式押具舌 P2466代替 P2446/2447

MODEL	SUB-CLASS	NEEDLE CLAMP	NEEDLE PLATE	MAIN FEED DOG	DIFF. FEED DOG	PRESSER FOOT	LOOPER	SPREADER	NEEDLE	Motor
機型	規格	針座	針板	主送具	差送具	押具	勾針	上叉	針號	馬達
F007JD-U122 /FP/K	232	M5232	E 1613	D 1206	H 1257	P 4011	ME28P	—	TV*5 #14	T6400UPM
F007JD-W123 /K	240	M5240	E 1534	D 1206	H 1258	P 2544	ME28	MH41	UY128GAS #10	
	248	M5248	E 1535	D 1206	H 1258	P 2545				
	356	M5356	E 1836	D 1207	H 1259	P 2446				
	364	M5364	E 1837	D 1207	H 1259	P 2447				
F007JD-W 123 /UTG(UTJ)/K	240	M5240	E 1534	D 1206	H 1258	P 2544	ME28	MH41	UY128GAS #10	
	248	M5248	E 1535	D 1206	H 1258	P 2545				
	356	M5356	E 1836	D 1207	H 1259	P 2446				
	364	M5364	E 1837	D 1207	H 1259	P 2447				
F007JD-W162 /K	356	M5356	E 1846	D 1207	H 1259	P 2446	ME28A	MH41	TV*5 #14~16	
	364	M5364	E 1847	D 1207	H 1259	P 2447				
F007JD-U162 /K	356	M5356	E 1846	D 1207	H 1259	P 2446	ME28A	—	TV*5 #14~16	
	364	M5364	E 1847	D 1207	H 1259	P 2447				
F007JD-W162 /UTG(UTJ)/K	356	M5356	E 1846	D 1207	H 1259	P 2446	ME28A	MH41	TV*5 #14~16	
	364	M5364	E 1847	D 1207	H 1259	P 2447				
F007JD-U162 /UTH(UTK)/K	356	M5356	E 1846	D 1207	H 1259	P 2446	ME28A	—	TV*5 #14~16	
	364	M5364	E 1847	D 1207	H 1259	P 2447				
F007JD-W222 /FQ/K	240	M5240	E 3024	D 1215	H 1261	P 1814	ME28	MH41	UY128GAS #10	
	248	M5248	E 3025	D 1215	H 1261	P 1815				
	356	M5356	E 3326	D 1216	H 1262	P 2116				
	364	M5364	E 3327	D 1216	H 1262	P 2117				
F007JD-W222 /UTG(UTJ)/FQ/K	240	M5240	E 3024	D 1215	H 1261	P 1814	ME28	MH41	UY128GAS #10	
	248	M5248	E 3025	D 1215	H 1261	P 1815				
	356	M5356	E 3326	D 1216	H 1262	P 2116				
	364	M5364	E 3327	D 1216	H 1262	P 2117				
F007JD-U222 /UTH(UTK)/FQ/K	240	M5240	E 3024	D 1215	H 1261	P 1814	ME28	MH41	UY128GAS #10	
	248	M5248	E 3025	D 1215	H 1261	P 1815				
	356	M5356	E 3326	D 1216	H 1262	P 2116				
	364	M5364	E 3327	D 1216	H 1262	P 2117				

註：P2544 /2545 為固定式押具舌，亦可使用活動式押具舌 P2565 代替 P2544 /P2545  
P2446 /2447 為固定式押具舌，亦可使用活動式押具舌 P2466 代替 P2446 /2447

## 規格件表 CONVERSION CHART-13









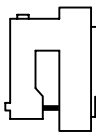

# 規格件表 CONVERSION CHART-14

MODEL	SUB-CLASS	NEEDLE CLAMP	NEEDLE PLATE	MAIN FEED DOG	DIFF. FEED DOG	PRESSER FOOT	LOOPER	SPREADER	NEEDLE	Motor
機型	規格	針座	針板	主送具	差送具	押具	勾針	上叉	針號	馬達
F007JD-W222 /FQ/FEC(FAC)/K	240	M5240	E 3024	D1215	H1261	P1814	ME28	MH41	UY128GAS #10	馬達
	248	M5248	E 3025	D1215	H1261	P1815				
	356	M5356	E 3326	D1216	H1262	P2116				
	364	M5364	E 3327	D1216	H1262	P2117				
F007JD-U222 /FQ/K	240	M5240	E 3024	D1215	H1261	P2314	ME28	—	UY128GAS #10	馬達
	248	M5248	E 3025	D1215	H1261	P2315				
	356	M5356	E 3326	D1216	H1262	P2616				
	364	M5364	E 3327	D1216	H1262	P2617				
F007JD-W222A /FQ/FEC(FAC)/K	240	M5240	E 3124	D1315	H1261	P1914	ME28	MH41	UY128GAS #10	馬達
	248	M5248	E 3125	D1315	H1261	P1915				
	356	M5356	E 3426	D1316	H1262	P2216				
	364	M5364	E 3427	D1316	H1262	P2217				
F007JD-W222 /FFP/K	240	M5240	E 3024	D1215	H1261	P1814	ME28	MH41	UY128GAS #10	馬達
	248	M5248	E 3025	D1215	H1261	P1815				
	356	M5356	E 3326	D1216	H1262	P2116				
	364	M5364	E 3327	D1216	H1262	P2117				
F007JD-U222 /FFP/K	240	M5240	E 3024	D1215	H1261	P2314	ME28	—	UY128GAS #10	馬達
	248	M5248	E 3025	D1215	H1261	P2315				
	356	M5356	E 3326	D1216	H1262	P2616				
	364	M5364	E 3327	D1216	H1262	P2617				
F007JD-W322 /FDC/K	356	M5356	E 4826	D1207	H1359	P2446	ME28	MH41	UY128GAS #10	馬達
	364	M5364	E 4827	D1207	H1359	P2447				
F007JD-W322 /UTG(UTJ)/FDC/K	356	M5356	E 4826	D1207	H1359	P2446	ME28	MH41	UY128GAS #10	馬達
	364	M5364	E 4827	D1207	H1359	P2447				
F007JD-U322 /FDC/K	356	M5356	E 4826	D1207	H1359	P2446	ME28	—	UY128GAS #10	馬達
	364	M5364	E 4827	D1207	H1359	P2447				
F007JD-U322 /UTH(UTK)/FDC/K	356	M5356	E 4826	D1207	H1359	P2446	ME28	—	UY128GAS #10	馬達
	364	M5364	E 4827	D1207	H1359	P2447				

W222A-FAC(FEC)短切刀

W222-FAC(FEC)長切刀

註：P2544/2545 為固定式押具舌，亦可使用活動式押具舌 P2565代替P2544/P2545  
P2446/2447 為固定式押具舌，亦可使用活動式押具舌 P2466代替P2446/2447

										
MODEL	SUB-CLASS	NEEDLE CLAMP	NEEDLE PLATE	MAIN FEED DOG	DIFF. FEED DOG	PRESSER FOOT	LOOPER	SPREADER	NEEDLE	Motor
機 型	規 格	針 座	針 板	主 送 具	差 送 具	押 具	勾 針	上 叉	針 號	馬 達
F007JD-W322 /FDE/K	356 364	M5356 M5364	E 4836M E 4837M	D1207 D1207	H1459 H1459	P2446 P2447	ME28	MH41	UY128GAS #10	T6400UPM
F007JD-W322 /UTG(UTJ)/FDE/K	356 364	M5356 M5364	E 4836M E 4837M	D1207 D1207	H1459 H1459	P2446 P2447	ME28	MH41	UY128GAS #10	
F007JD-U322 /FDE/K	356 364	M5356 M5364	E 4836M E 4837M	D1207 D1207	H1459 H1459	P2446 P2447	ME28	—	UY128GAS #10	
F007JD-U322 /UTH(UTK)/FDE/K	356 364	M5356 M5364	E 4836M E 4837M	D1207 D1207	H1459 H1459	P2446 P2447	ME28	—	UY128GAS #10	
F007JD-W522 /FE/FR/K	240 248 356 364	M5240 M5248 M5356 M5364	E 6024 E 6025 E 6326 E 6327	D 2221 D 2221 D 2222 D 2222	H 2267 H 2267 H 2268 H 2268	P 2814 P 2815 P 3116 P 3117	ME28	MH41	UY128GAS #10	
F007JD-U522 /FE/FR/K	240 248 356 364	M5240 M5248 M5356 M5364	E 6024 E 6025 E 6326 E 6327	D 2221 D 2221 D 2222 D 2222	H 2267 H 2267 H 2268 H 2268	P 2814 P 2815 P 3116 P 3117	ME28	—	UY128GAS #10	
F007JD-W512 /FE/K	240 248 356 364	M5240 M5248 M5356 M5364	E 1524 E 1525 E 1826 E 1827	D 1206 D 1206 D 1207 D 1207	H 1258 H 1258 H 1259 H 1259	P 2914 P 2915 P 3216 P 3217	ME28	MH41	UY128GAS #10	
F007JD-U512 /FE/K	240 248 356 364	M5240 M5248 M5356 M5364	E 1524 E 1525 E 1826 E 1827	D 1206 D 1206 D 1207 D 1207	H 1258 H 1258 H 1259 H 1259	P 3414 P 3415 P 3716 P 3717	ME28	—	UY128GAS #10	

註： F007JD-W/U322A-<sup>356</sup><sub>364</sub> /FDC 時，該針板與送具改用 F007H-W/U122-<sup>356</sup><sub>364</sub> 之針板與送具

註： P2544/2545 為固定式押具舌，亦可使用活動式押具舌 P2565 代替 P2544 /P2545  
P2446/2447 為固定式押具舌，亦可使用活動式押具舌 P2466 代替 P2446 /2447



# 規格件表 CONVERSION CHART-16

MODEL	SUB-CLASS	NEEDLE CLAMP	NEEDLE PLATE	MAIN FEED DOG	DIFF. FEED DOG	PRESSER FOOT	LOOPER	SPREADER	NEEDLE	Motor
機型	規格	針座	針板	主送具	差送具	押具	勾針	上叉	針號	馬達
F007JD-U613 /FBP/K	256	M5356	E 1836L	D 1207	H 1259	P 4000	ME28	—	TV*5 #14~18	T6400UPM
	264	M5364	E 1837L	D 1207	H 1259	P 4001	ME28	—		
F007JD-U712 /K	264	M5264	E 5827	D 5207	H 5259	P 4117	ME28	—	TV*3 #11~16	
	264	M5264	E 5827	D 5207	H 5259	P5117(破品寬1.0mm用)	FS03/04	—	TV*3 #11~16	
F007JD-U712A /FSP/K	264	M5264	E 5827	D 5207	H 5259	P5118(破品寬1.2mm用)	FS03/04	—	TV*3 #11~16	
	264	M5264	E 5927	D 5307	H 5359	P 4217	FS03/04	—	TV*7 #12~14	
F007JD-U712 /FSR/K	388	M4388	E 6828	D 6207	H 6259	P 6117	FS03/04/FY02	FY09	TV*7 #12	
	456 460 464	M5456 M5460 M5464	E1828P E1838P E1848P	D1207P	H1259	P2428P P2438P P2448P	FW28	MH41	SM1014B #10 (MY1014B #70 ,SY7256)	

F007J: 為一般馬達,外置式機種 ; F007JD: 為加裝直驅伺服馬達機種



# PARTS LIST FOR MB GROUP

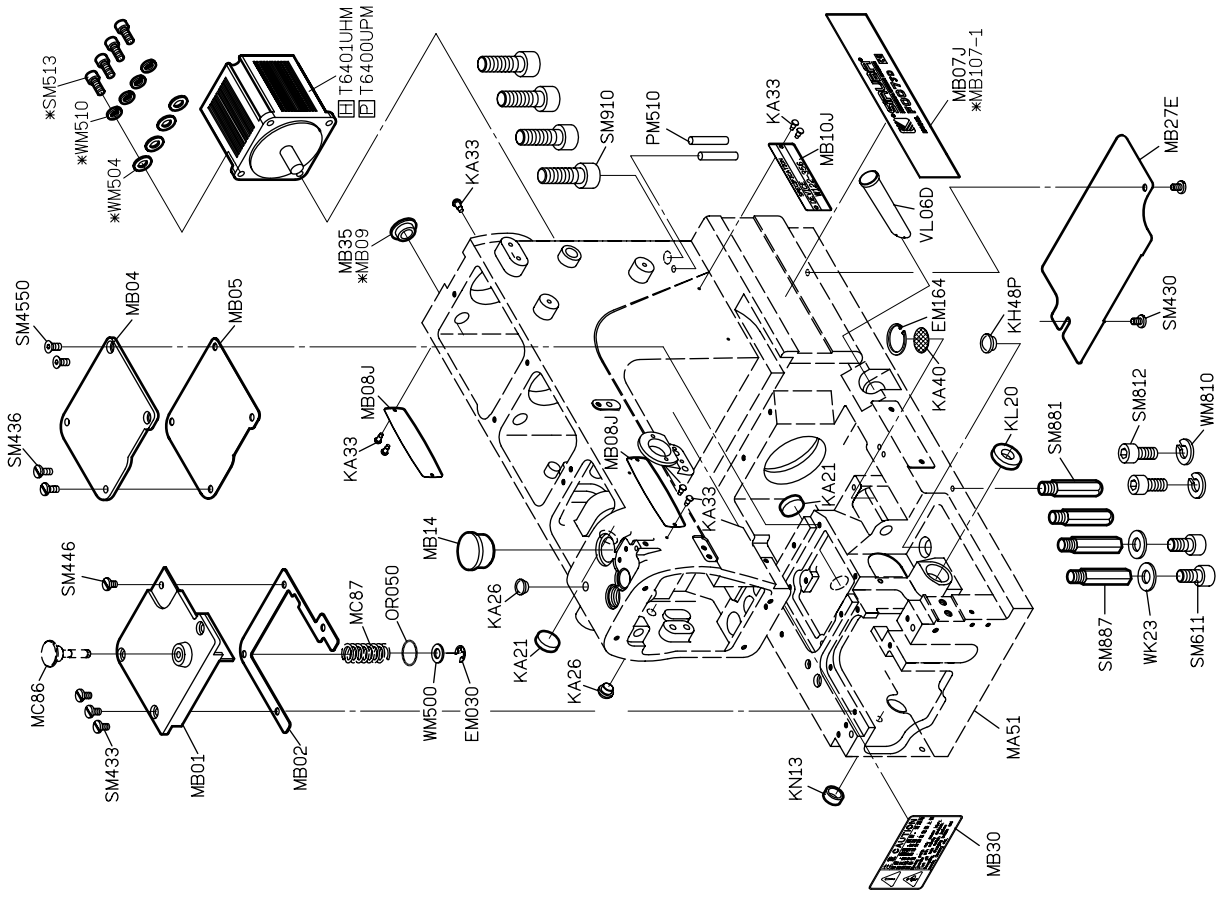

FOR F007J/F007JD  FOR F007JD H牌馬達  
 \* USE FOR F007JD  FOR F007JD P牌馬達

# PARTS LIST FOR MC GROUP

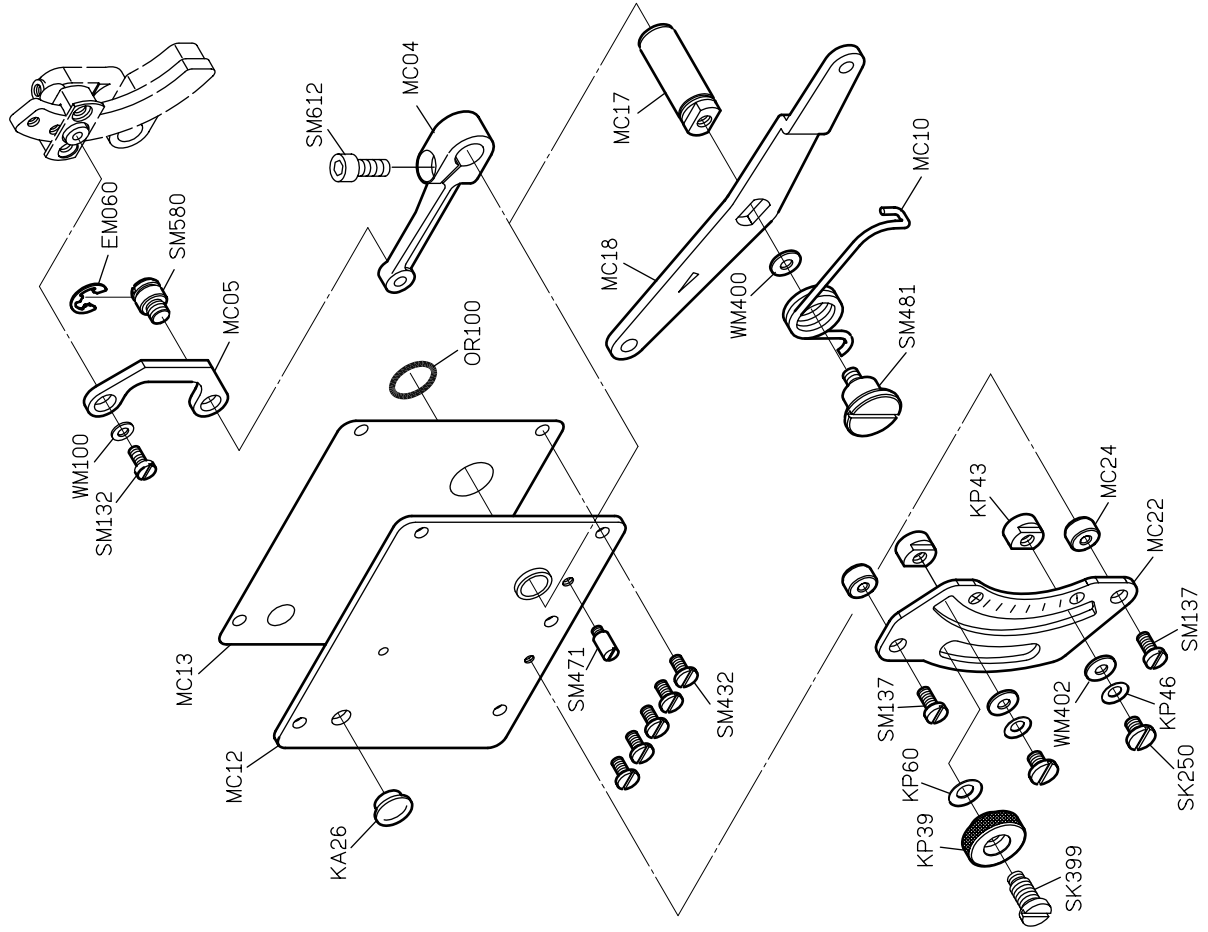





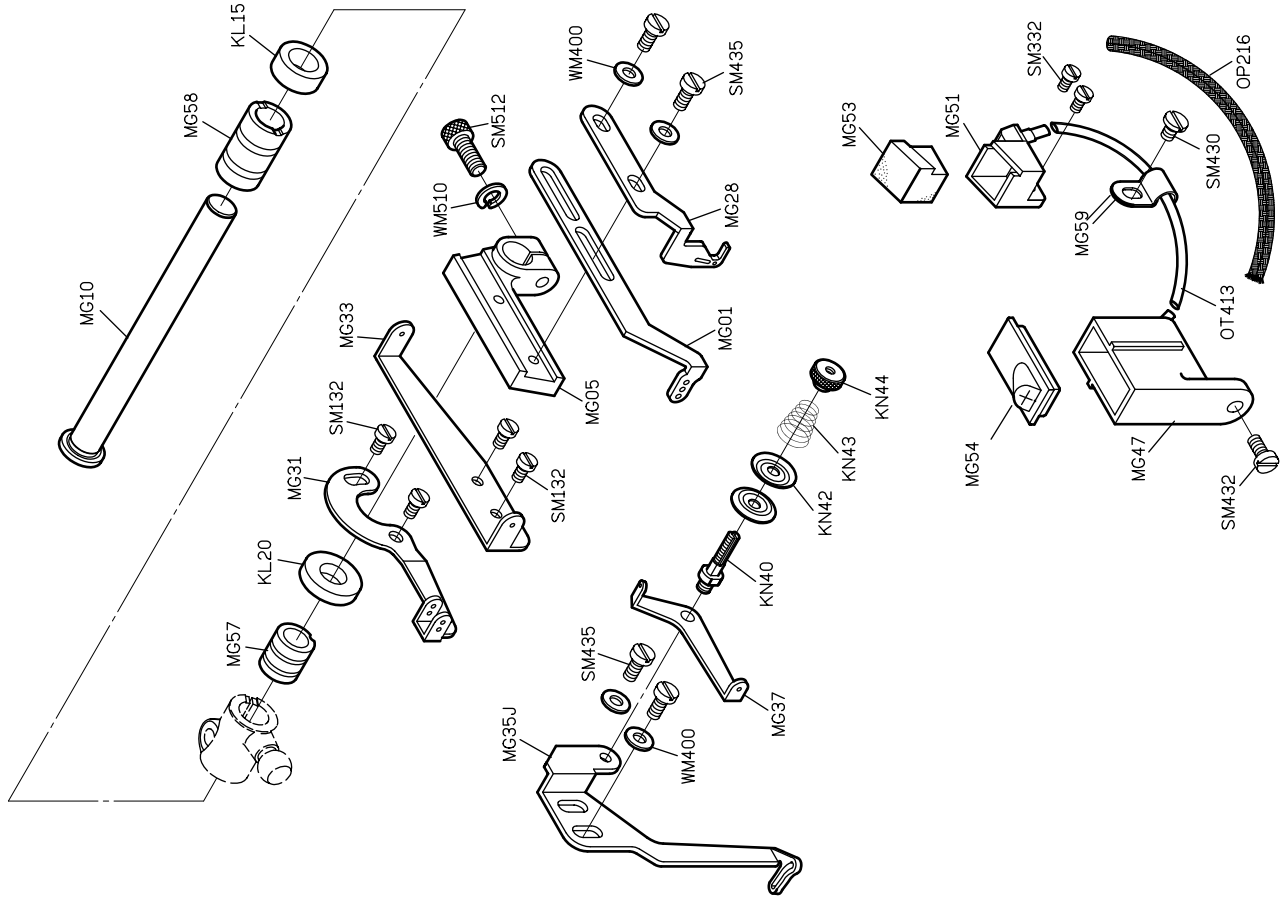

PARTS LIST FOR MG GROUP

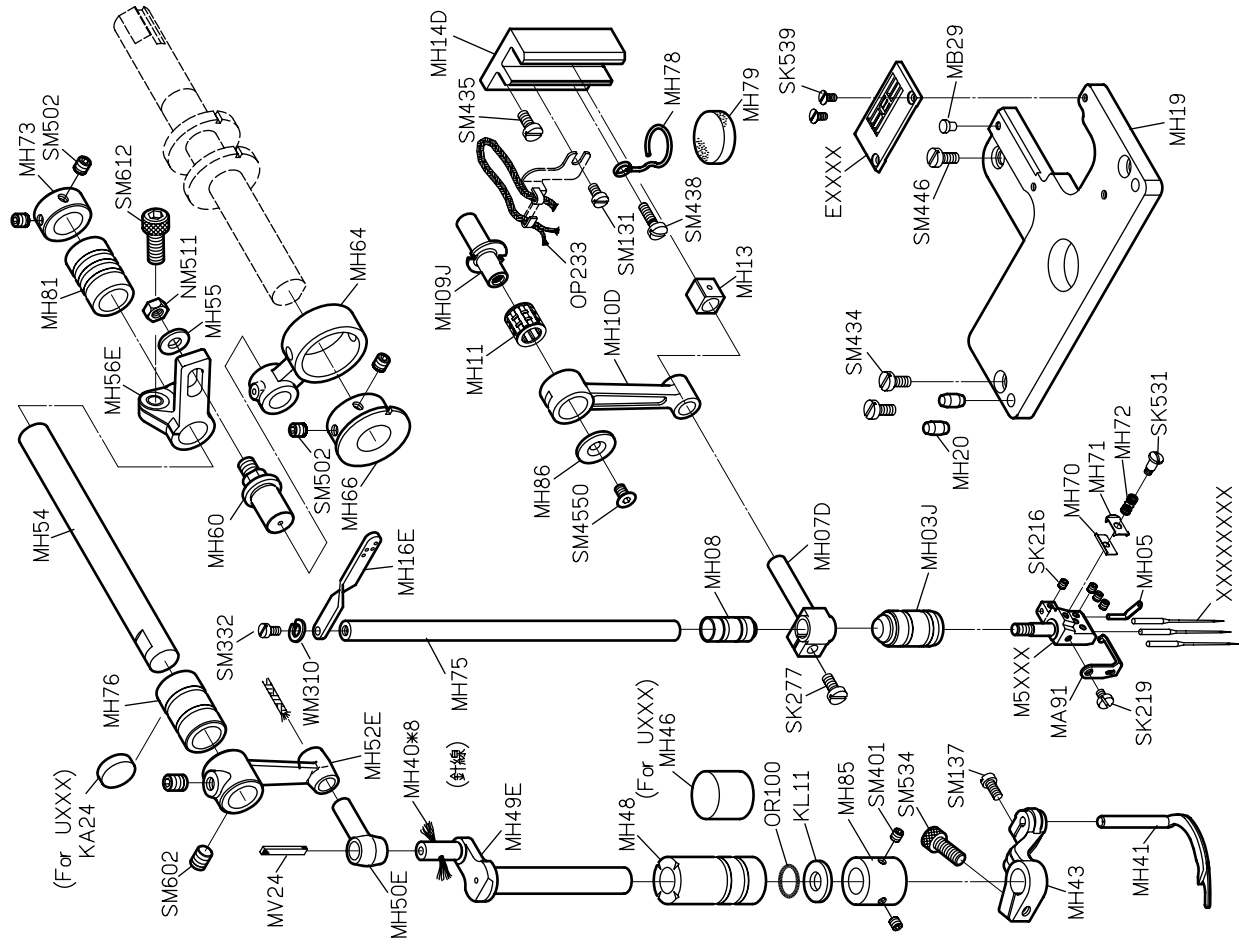

PARTS LIST FOR MH GROUP

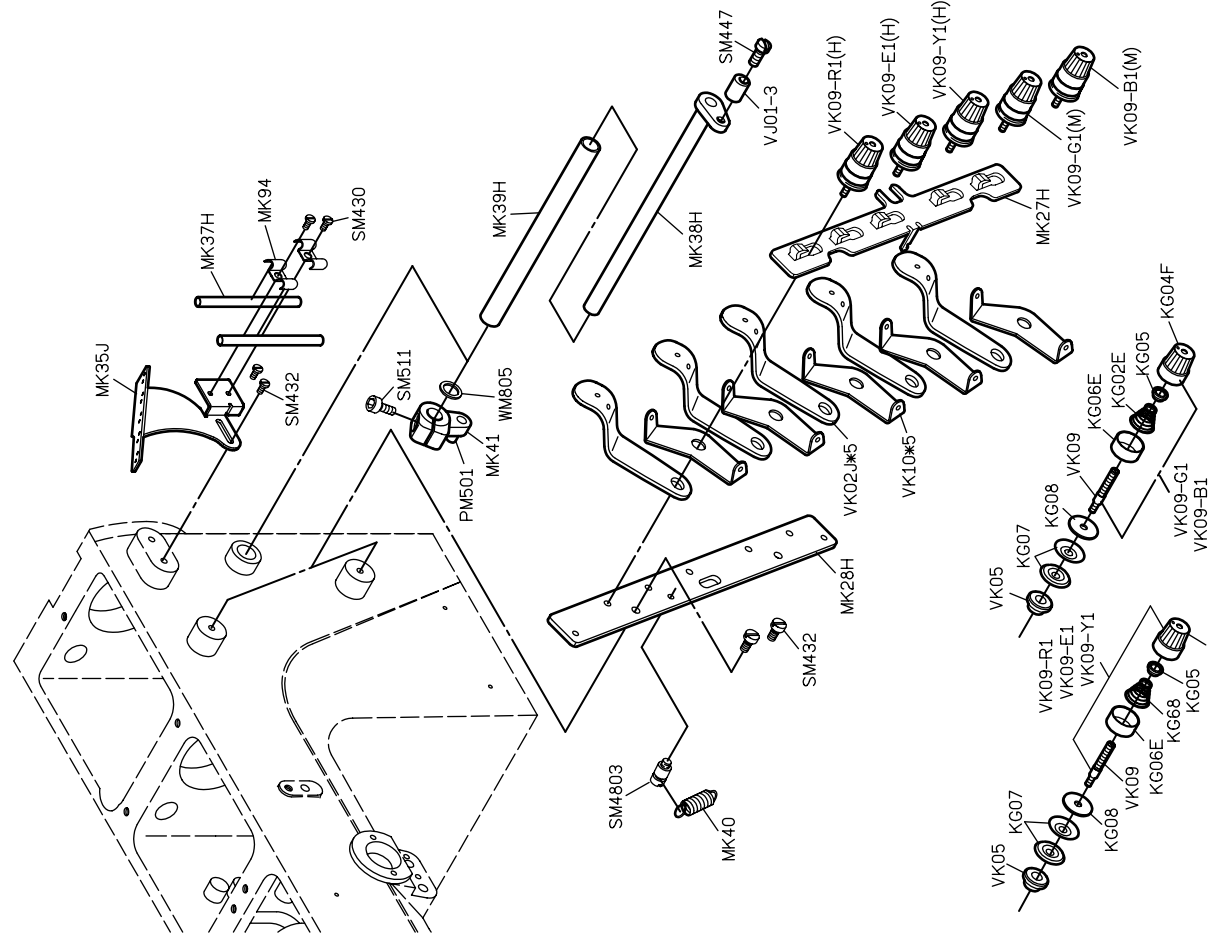
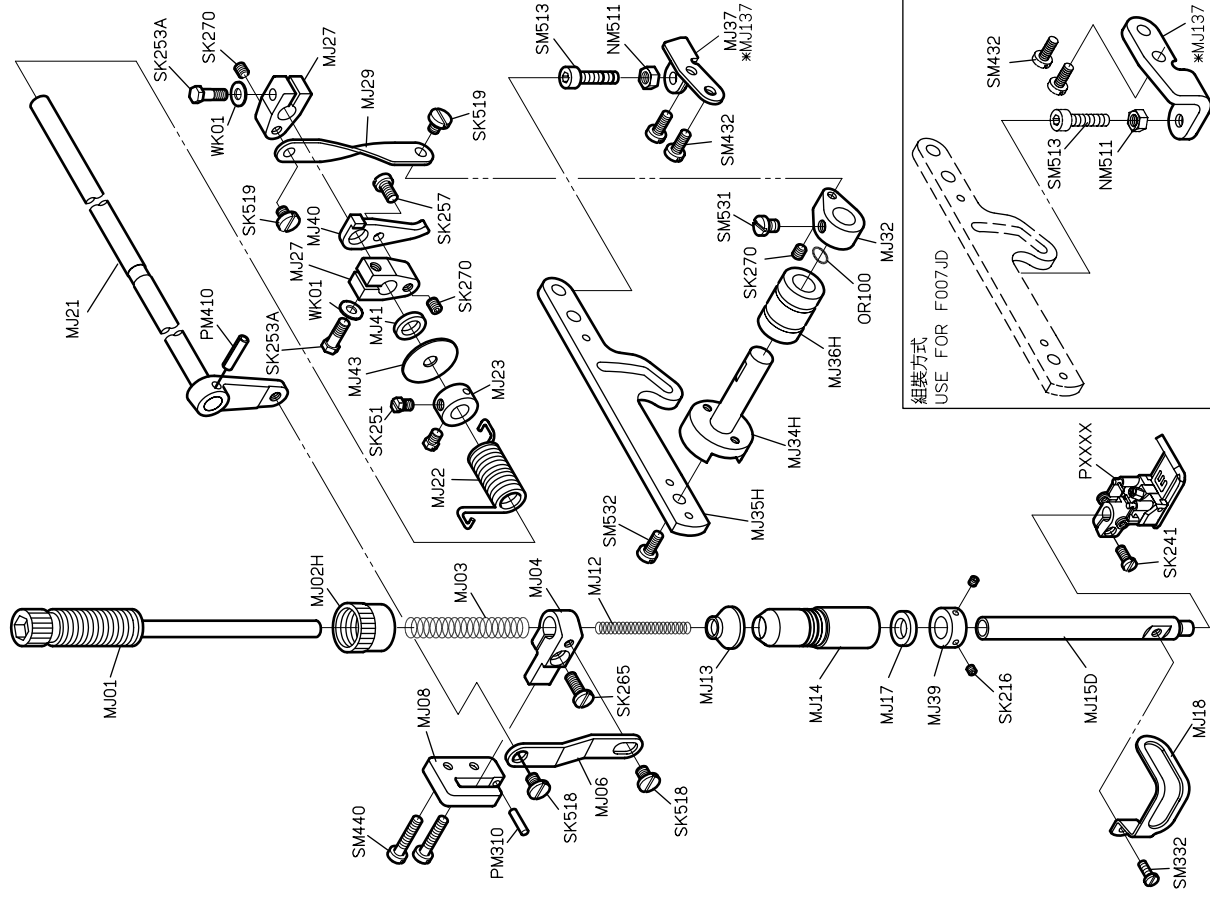

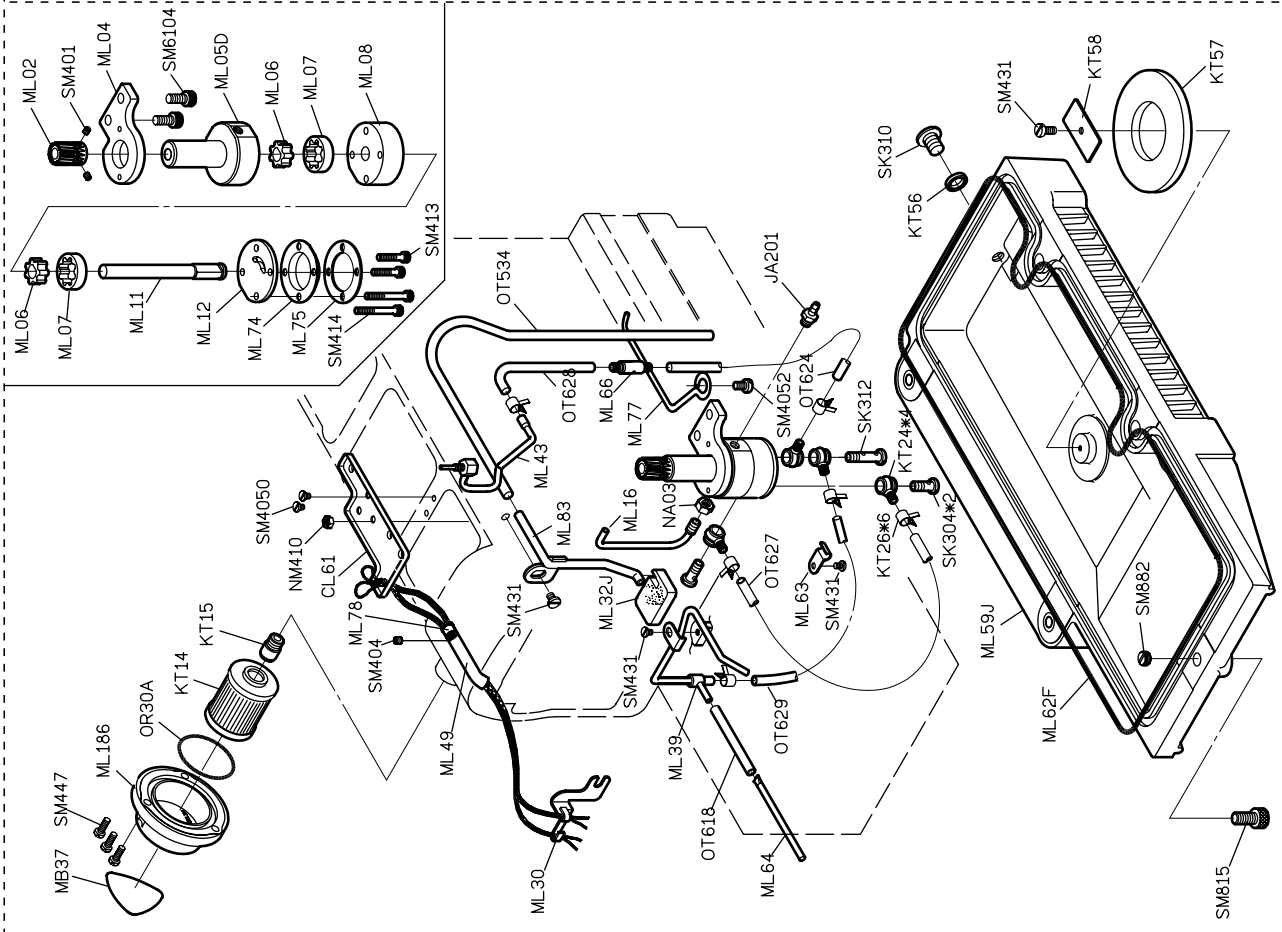

PARTS LIST FOR ML GROUP

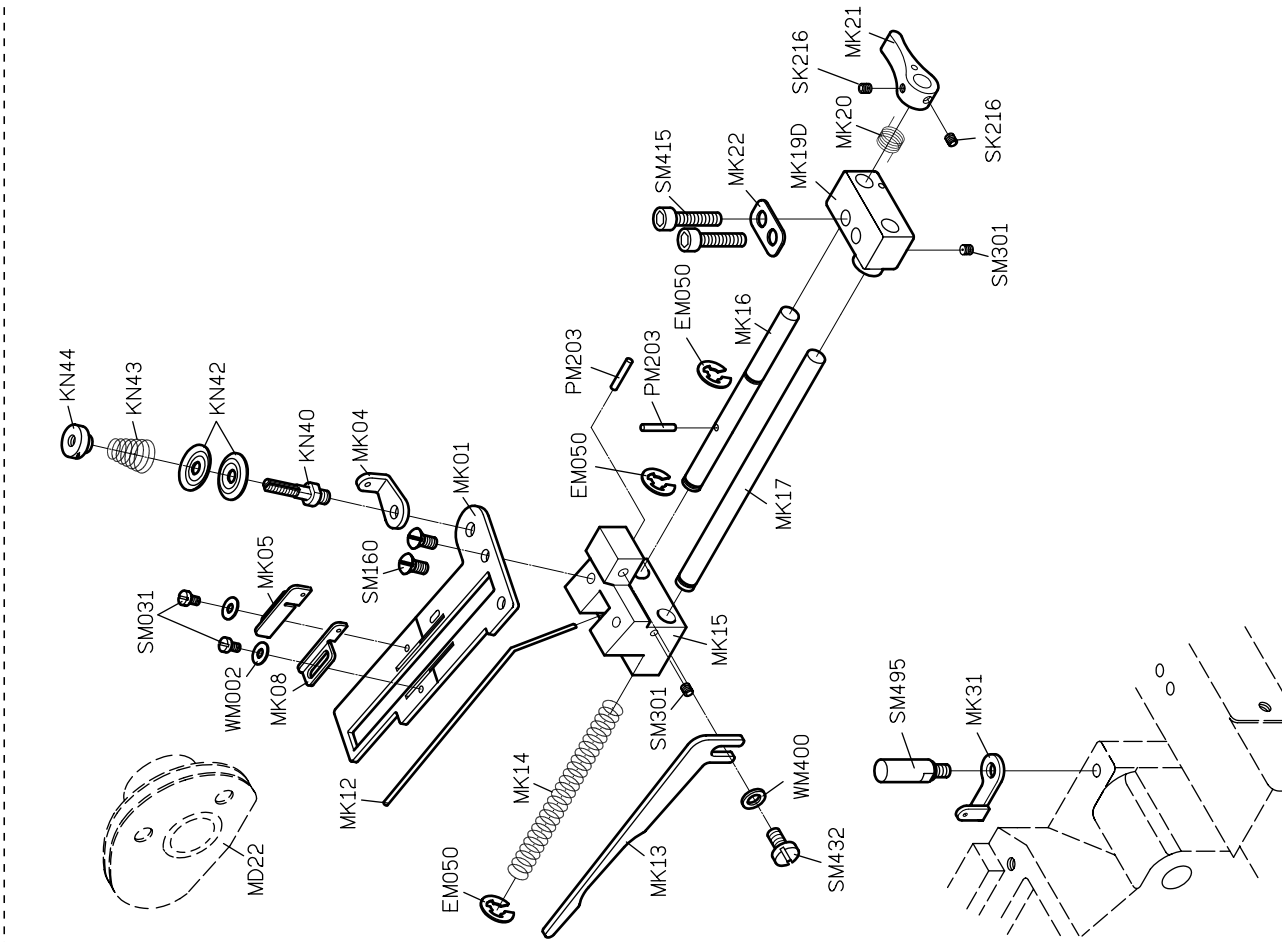

PARTS LIST FOR MK GROUP



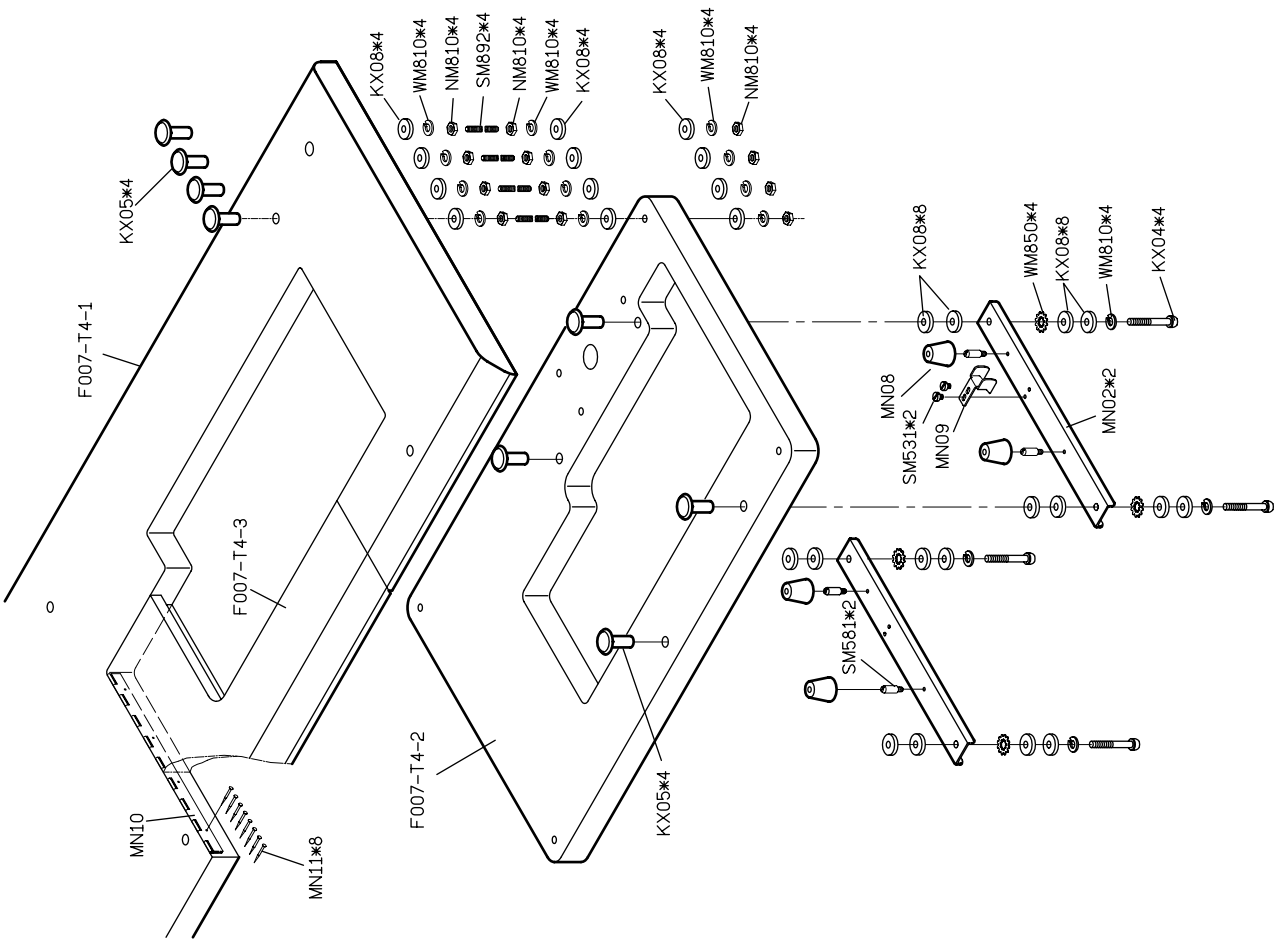
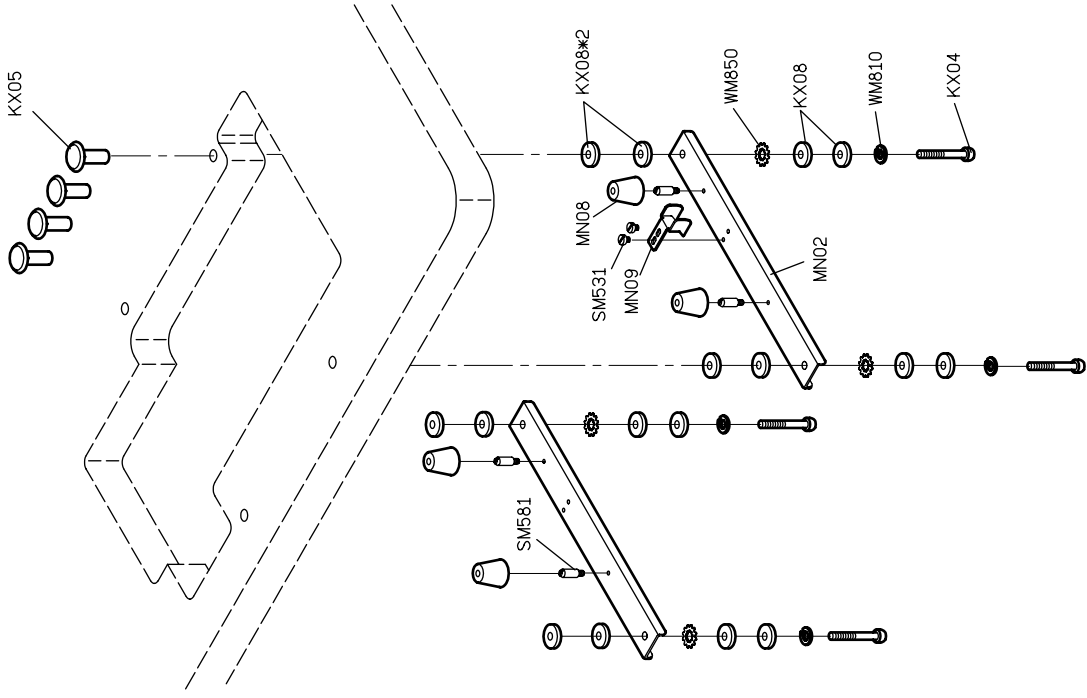



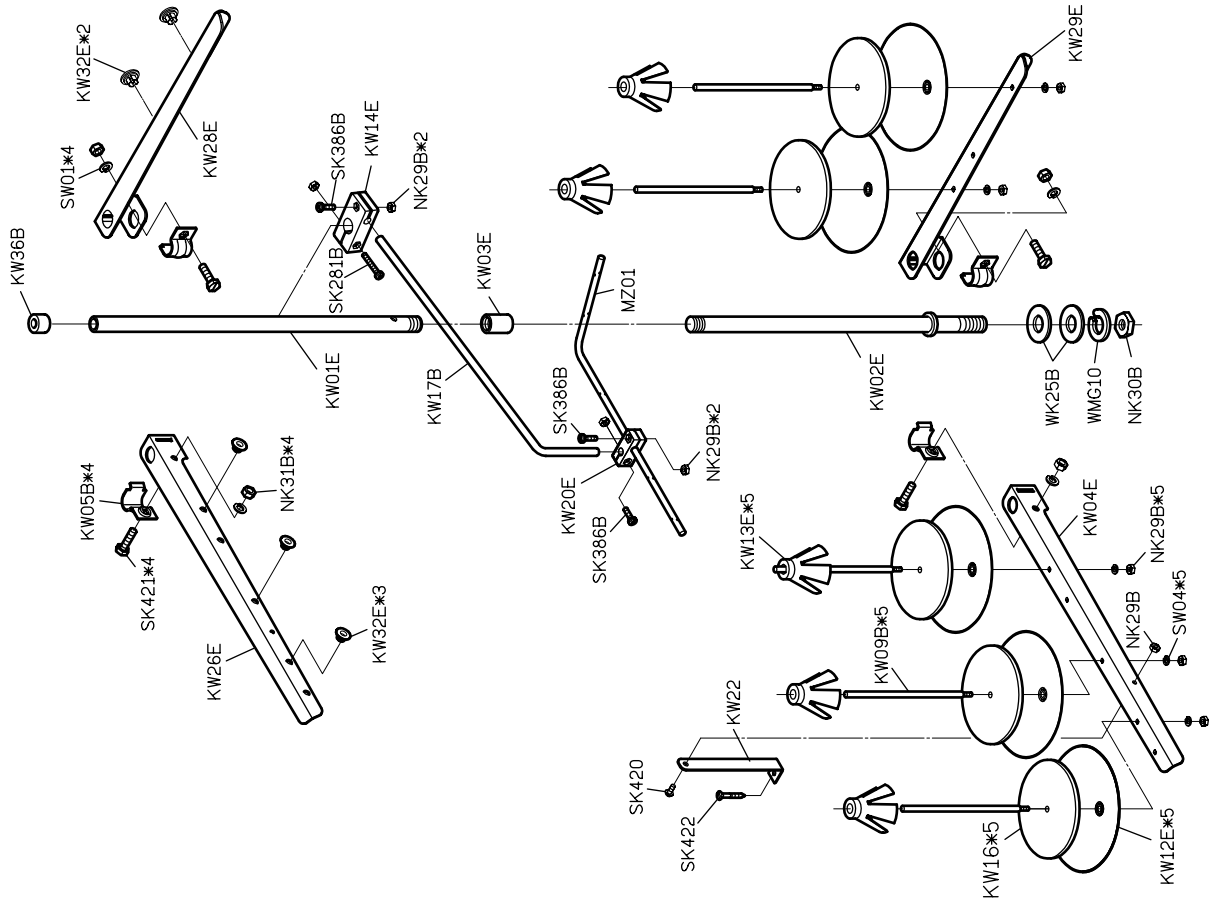



# F007J/F007JD

高林股份有限公司 KAULIN MFG. CO., LTD.